

# Keysight U117A IR-to-Bluetooth Adapter

## Operating Instructions

The Keysight U117A Infrared (IR)-to-**Bluetooth**<sup>®1</sup> adapter is designed to be used with the Keysight U1200 Series handheld meters. The U117A adapter enables you to connect the handheld meter to the Keysight U1115A remote logging display or Windows PC/Android devices/iOS devices via the Keysight mobile application/PC application software for a total wireless remote connectivity solution of up to 100-metres<sup>2</sup>.

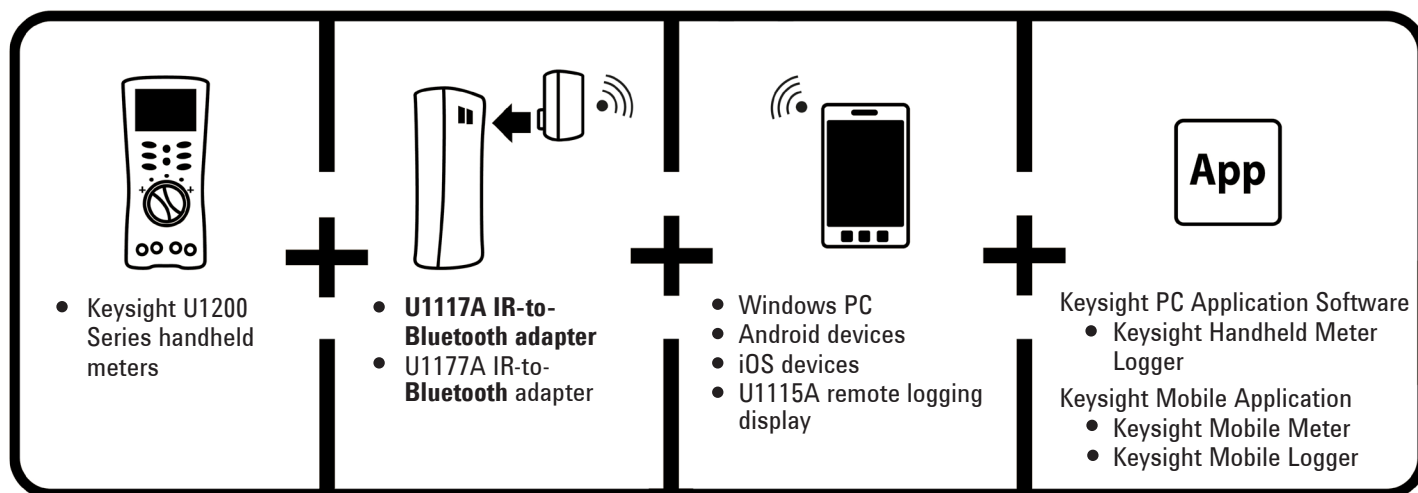

Figure 1. Keysight wireless remote connectivity solution

## Standard Shipped Items Checklist

The following items are included when you make a purchase:

- U117A IR-to-**Bluetooth** adapter
- Two 1.5 V AAA batteries
- Operating Instructions (this sheet)

<sup>1</sup> The **Bluetooth**<sup>®</sup> word mark and logos are registered trademark owned by **Bluetooth** SIG, Inc and any use of such marks by Keysight is under license. Other trademark and trade names are those of their respective owners.

<sup>2</sup> Only applicable when connected to any dongle with **Bluetooth** Class 1 classification.



# Product Characteristics

<b>Temperature</b>	<b>Operating condition:</b> –20 °C to 55 °C <b>Storage condition:</b> –40 °C to 70 °C
<b>Relative Humidity (R.H.)</b>	<b>Operating condition:</b> Up to 80% at 40 °C (non-condensing) <b>Storage condition:</b> Up to 95% at 40 °C (non-condensing)
<b>Dimension (W x L x H)</b>	39.0 mm × 71.0 mm × 37.0 mm
<b>Weight</b>	60 g with batteries
<b>Battery Type</b>	<ul style="list-style-type: none"> <li>• Lithium 24–LF (ANSI) and FR03 (IEC)</li> <li>• Alkaline 24 A (ANSI/NEDA) and LR03 (IEC)</li> <li>• Zinc Chloride 24 D (ANSI/NEDA) and R03 (IEC)</li> </ul>
<b>Battery Lifespan</b>	Lithium batteries: 30 hours Alkaline batteries: 20 hours
<b>Power Consumption</b>	Maximum 561 mVA for two 1.5 V AAA batteries
<b>Warranty</b>	Three months (Does not cover normal wear and tear of mechanical parts and batteries)
<b>Bluetooth</b>	<b>Bluetooth</b> SPP profile, Class 1 device, range up to 100 m
<b>Compatibility</b>	<p><b>Keysight Handheld Meter/Display:</b></p> <ul style="list-style-type: none"> <li>• Keysight U1200 Series Handheld Meters</li> <li>• Keysight U1115A Remote Logging Display</li> </ul> <p><b>Keysight PC Application Software:</b></p> <ul style="list-style-type: none"> <li>• Keysight Handheld Meter Logger</li> </ul> <p><b>Keysight Mobile Application:</b></p> <ul style="list-style-type: none"> <li>• Keysight Mobile Meter</li> <li>• Keysight Mobile Logger</li> </ul> <p><b>Hardware Devices:</b></p> <ul style="list-style-type: none"> <li>• iPhone</li> <li>• iPad</li> <li>• iPod Touch</li> <li>• Android smartphone/tablet</li> <li>• Windows PC (with <b>Bluetooth</b>-enabled)</li> </ul>

<p><b>Regulatory</b></p> <div style="border: 1px solid black; padding: 5px; margin: 10px 0;"> <p>Complies with IDA Standards DB 102425</p> </div>	<p>The U1117A complies with the requirements of the following product standards:</p> <ul style="list-style-type: none"> <li>• EMC <ul style="list-style-type: none"> <li>• EN 301 489–1V1.9.2</li> <li>• EN 301 489–17:V2.1.1</li> <li>• EN 55022:2006+A1:2007</li> <li>• EN55024:1998+A1:2001+A2:2003</li> </ul> </li> <li>• RF (<b>Bluetooth</b>) <ul style="list-style-type: none"> <li>• EN 300 328 V1.7.1 (2006–10)</li> </ul> </li> <li>• RF (Health) <ul style="list-style-type: none"> <li>• EN 62311:2008</li> </ul> </li> <li>• Safety <ul style="list-style-type: none"> <li>• EN 60950–1:2006+A11:2009+A12:2011</li> </ul> </li> <li>• India Equipment Type Approval (ETA) Certificate No: 1424/2011/WRLO</li> <li>• COFETEL Certificate No: RCPAGU111-1066, registered under Keysight Technologies Mexico S de RL de CV</li> </ul> <p>“This telecommunication equipment conforms to the NTC technical requirement”</p>
---	---

**NOTE**

- FCC: The device contains FCC ID: Q0QWT111A
- Canada IC: The device contains transmitter IC: 5123A–BGTWT111A
- To comply with FCC and Industry Canada RF radiation exposure limits for general population, the antenna(s) used for this transmitter must be installed such that a minimum separation distance of 20cm is maintained between the radiator (antenna) and all persons at all times and must not be colocated or operating in conjunction with any other antenna or transmitter.
- “La operación de este equipo está sujeta a las siguientes dos condiciones: (1) es posible que este equipo o dispositivo no cause interferencia perjudicial y (2) este equipo o dispositivo debe aceptar cualquier interferencia, incluyendo la que pueda causar su operación no deseada.”

## NOTE

- “Este produto está homologado pela Anatel, de acordo com os procedimentos regulamentados pela Resolução nº 242/2000 e atende aos requisitos técnicos aplicados, incluindo os limites de exposição da Taxa de Absorção Específica referente a campos elétricos, magnéticos e eletromagnéticos de radiofrequência de acordo com as Resoluções nº 303/202 e 533/2009”.
- “Este equipamento opera em caráter secundário, isto é, não tem direito a proteção contra interferência prejudicial, mesmo de estações do mesmo tipo, e não pode causar interferência a sistemas operando em caráter primário”.

Manter distância mínima de 10 cm do corpo humano.  
Para maiores informações, consulte o site da ANATEL  
[www.anatel.gov.br](http://www.anatel.gov.br)

## WARNING

- The radio module certified by Japanese Radio Law is integrated inside.
- NCC Warning Statement:
  - Article 12  
Without permission, any company, firm or user shall not alter the frequency, increase the power, or change the characteristics and functions of the original design of the certified lower power frequency electric machinery.
  - Article 14  
The application of low power frequency electric machineries shall not affect the navigation safety nor interfere a legal communication, if an interference is found, the service will be suspended until improvement is made and the interference no longer exists.

## Front View

### LED Indicator and Slide Switch

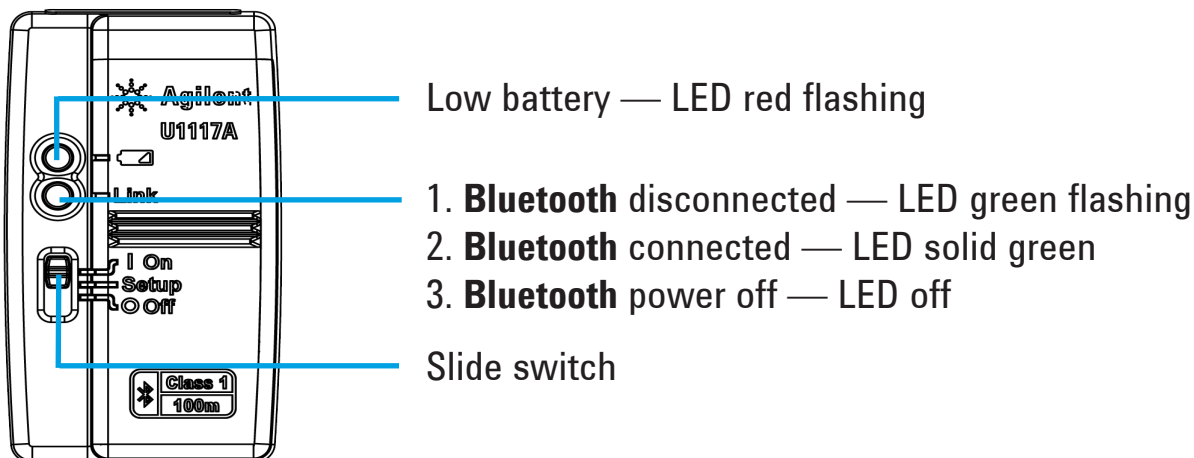

# Operation

## NOTE

- Do not open the plastic case unnecessarily. Doing so may cause damage to the plastic case.
- Keep the adapter away from getting wet.
- Ensure the adapter is turned OFF and the battery cover is removed when replacing the batteries.
- The batteries must be recycled or disposed properly after depletion.
- If the LED is not lighted when turned on, replace the batteries with new specified batteries.
- The adapter can only be used with Keysight handheld meters.

## Install and Replace the Batteries

## NOTE

Make sure you turn off the U1117A before installing or replacing the batteries.

## CAUTION

To avoid the U1117A being damage from battery leakage:

- Always remove dead batteries immediately.
- Always remove the batteries and store them seperately if the adapter is not going to be used for a long period.

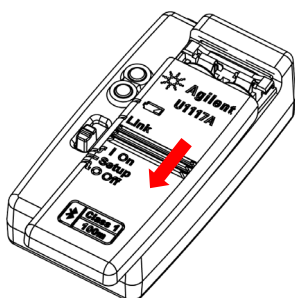

1. Slide the battery cover away from adapter's body.

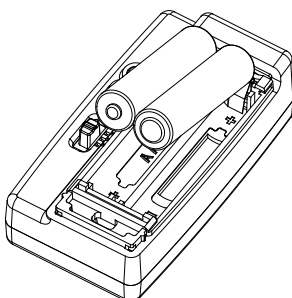

2. Insert the batteries.

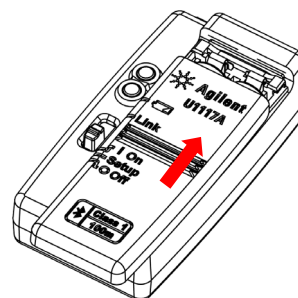

3. Reverse the sliding position to close the battery cover.

## Turn On the U1117A

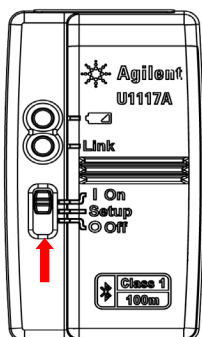

Set the slide switch to **On**.

## Configure the U1117A

The U1117A is designed to be used straight from the box without any configuration. However, if your hardware requires special configuration, you may setup the U1117A using the U1117A Configuration Utility— downloadable at [www.keysight.com/find/U1117A](http://www.keysight.com/find/U1117A)

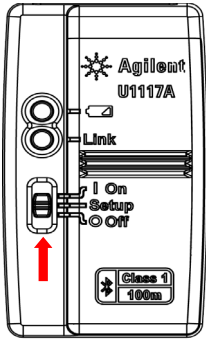

Set the slide switch to **Setup**.

## Reset the U1117A

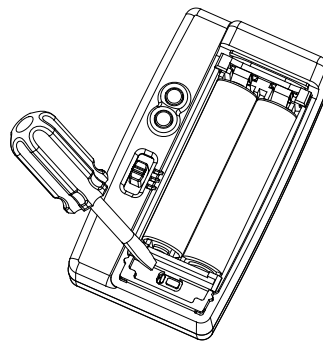
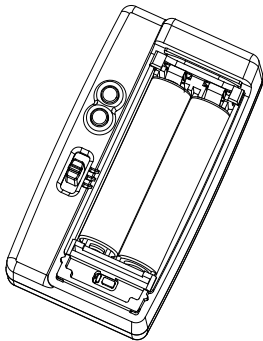

1. Open the battery cover. Then, set the slide switch to **Setup**.
2. Use a flat-blade screwdriver to push the button located in the hole for around three seconds.

## Connect Your U1117A Adapter to the Keysight Handheld Meter

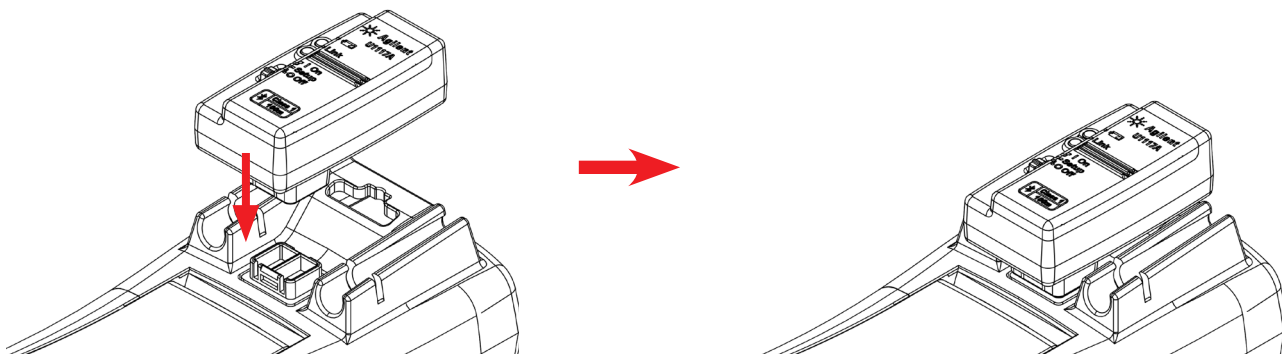

Snap the optic side of the U1117A to the handheld meter's IR communication port.

## Install the U1117A to PC via Bluetooth

### NOTE

- Before you begin, make sure the **Bluetooth** connection on your PC is enabled.
  - It is recommended to use brand new batteries before running any operations that are critical or require a longer duration.
  - In some cases, the Bluetooth Device Manager will create two COM ports. Use the COM port with the “Outgoing” label only.
- 

1. Set the U1117A slide switch to **On**.
2. From your PC (Windows 7), go to **Start > Devices and Printers**.
3. Click **Add a device**.
4. Select **Keysight U1117A-XXXXXX**—the XXXXXX represents U1117A device ID—and click **Next**.
5. Type the default **Bluetooth** pairing code “1234” and click **Next**.
6. Once pairing is successful, a notification window will appear. Click **Close**.
7. The **U1117A-XXXXXX** is now added and connected successfully to your PC.

## Connect a Meter to the Keysight Handheld Meter Logger via the U1117A

Before you begin, make sure you download the Keysight Handheld Meter Logger at [www.keysight.com/find/hhmeterlogger](http://www.keysight.com/find/hhmeterlogger)

1. Open the Keysight Handheld Meter Logger.
2. On the Connected Instruments List (at the bottom), select the **U1117A-XXXXX** and click **Connect** to establish the multimeter connection.
3. The multimeter will remain connected until the connection is disconnected or the U1117A is turned off.

### NOTE

- Only one host computer is able to connect to the U1117A at a time.
- 

## Connect a Meter to the Keysight U1115A Remote Logging Display via the U1117A

For details, refer to the *U1115A Remote Logging Display Operating Instructions* at [www.keysight.com/find/U1115A](http://www.keysight.com/find/U1115A).

# Connect a Meter Remotely via the Keysight Mobile Application (Keysight Mobile Apps)

You can now turn your Android and iOS devices into a remote measurement, control and reporting devices using both the Keysight Mobile Meter and Keysight Mobile Logger —available on the Google Play and App Store. These Mobile Apps allow you to wirelessly control your Keysight handheld meter with your Android devices and iOS devices via the Keysight U1117A adapter.

All Keysight handheld meters are supported, with the exception of the Keysight U1240 Series, which requires an additional Keysight U1179A IR Connectivity Bracket for compatibility with the Keysight U1117A adapter.

Visit the URL below for more information on the Keysight Mobile Apps:  
[www.keysight.com/find/hhmeterapp](http://www.keysight.com/find/hhmeterapp)

## Maintenance

If any part of the adapter is worn out or damaged, replace it with a new U1117A adapter.

## Assistance

For technical assistance, contact your nearest Keysight Sales Office or visit the Keysight website at [www.keysight.com/find/assist](http://www.keysight.com/find/assist) for further information.



U1117-90103

©Keysight Technologies 2014  
Printed in Malaysia  
November 2014



3025-13-7510



(01) 07898994220626